

# Drachensterne - Stern 9

basteln mit der

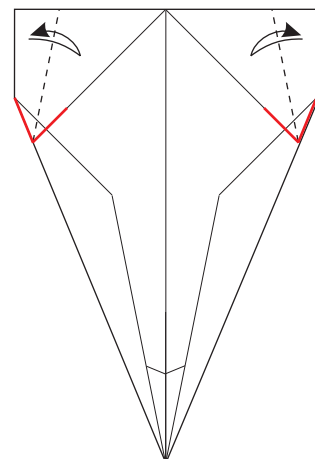

Benötigt werden 8 gleich große rechteckige Stücke Transparentpapier.

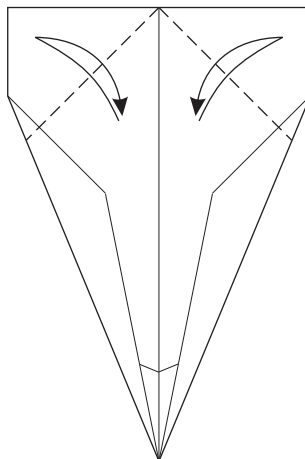
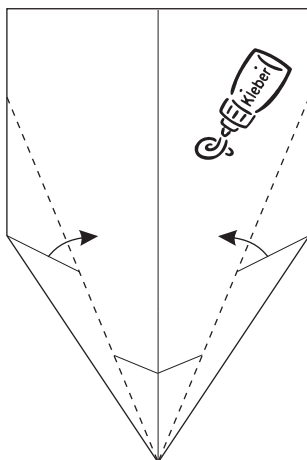
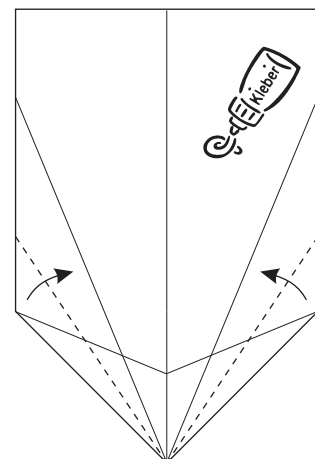
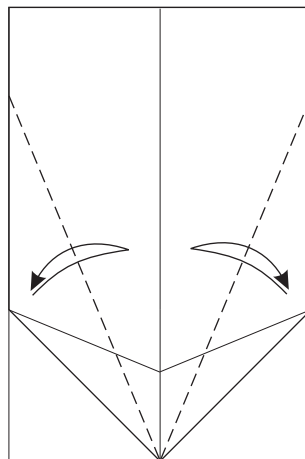
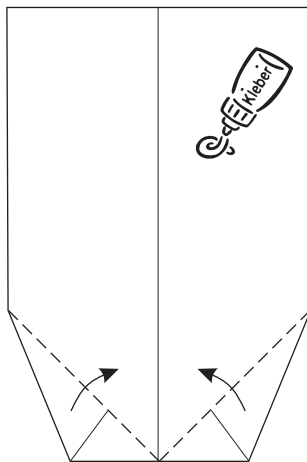
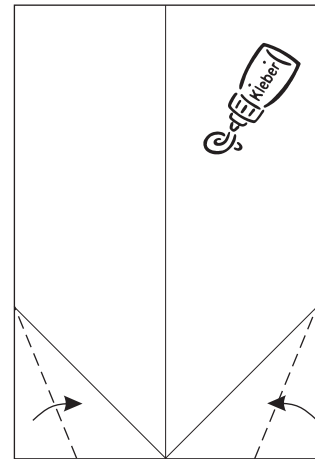
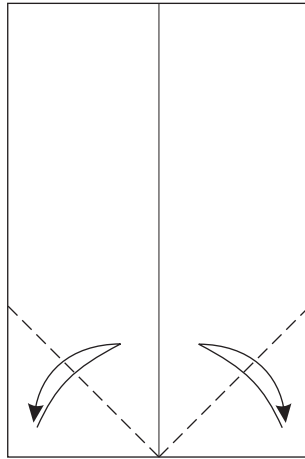
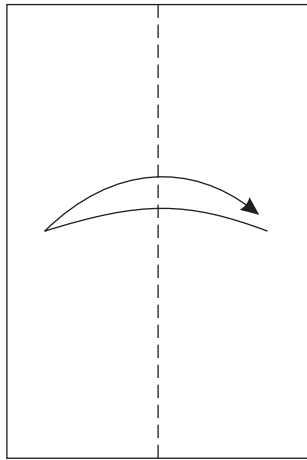

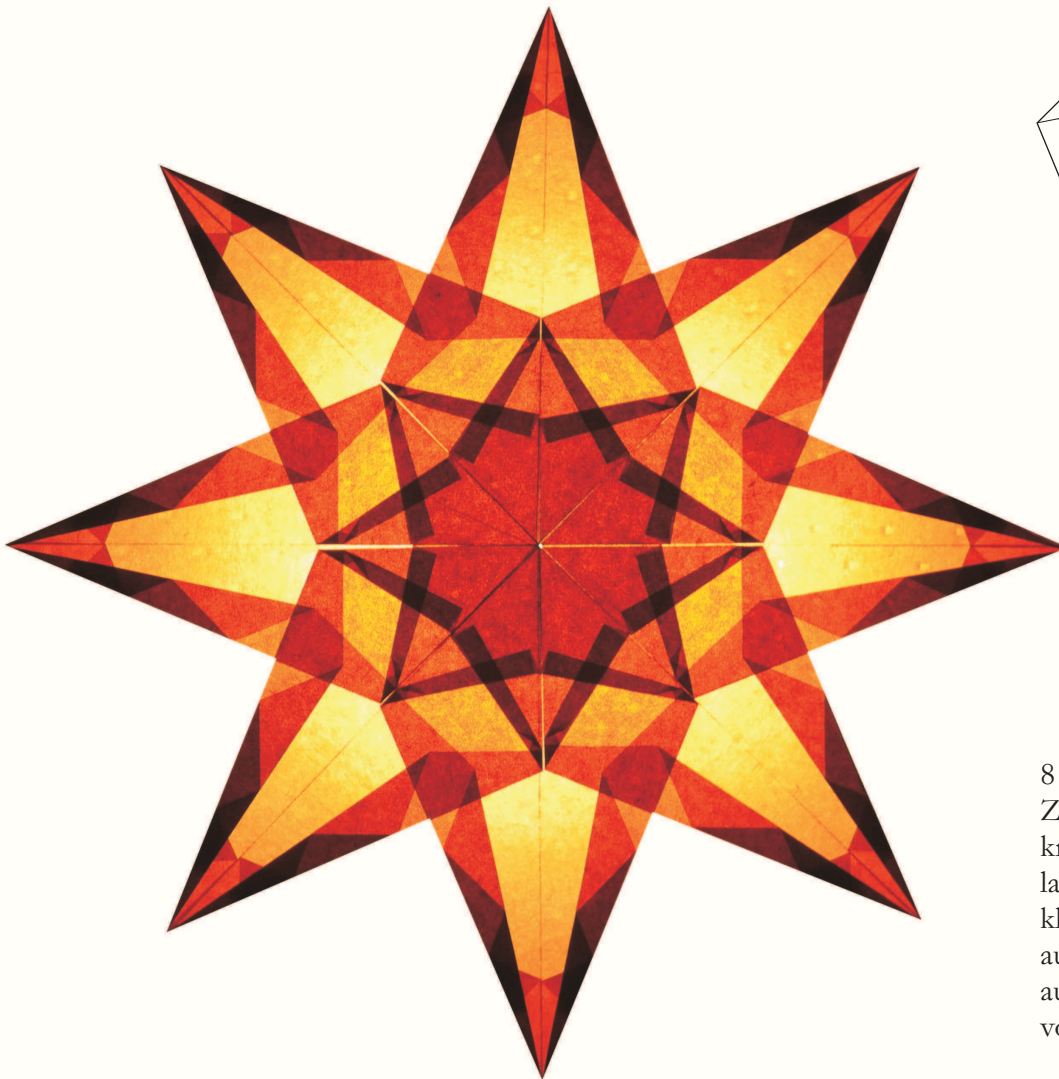
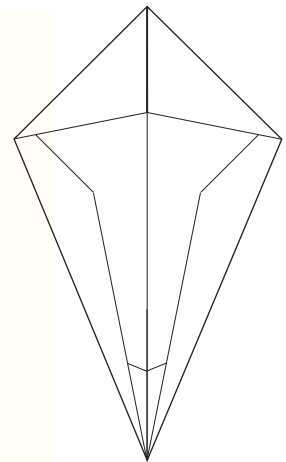
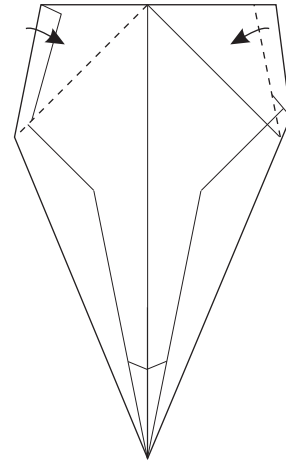
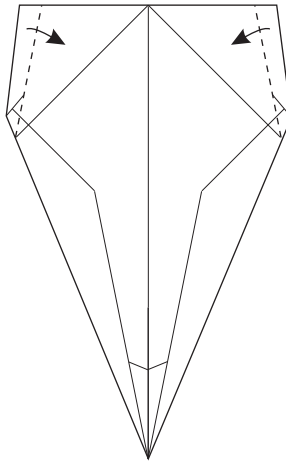
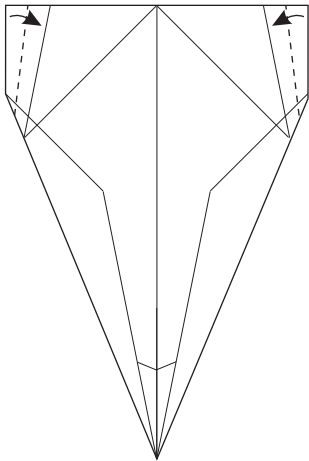

8 solcher Elemente falten.  
Zum Zusammenfügen  
kreisförmig und über-  
lappend aufeinander-  
kleben. Das letzte Teil  
auf einer Seite oben  
auf der anderen Seite  
von unten ankleben.