

# Drachensterne - Stern S-17

basteln mit der

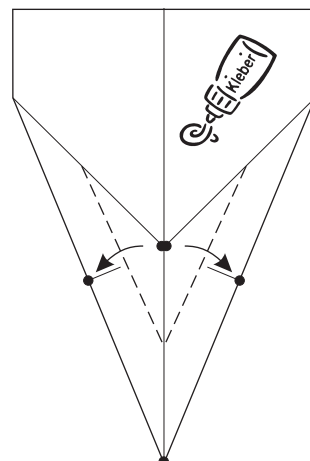

Benötigt werden 8 gleich große rechteckige Stücke Transparentpapier.

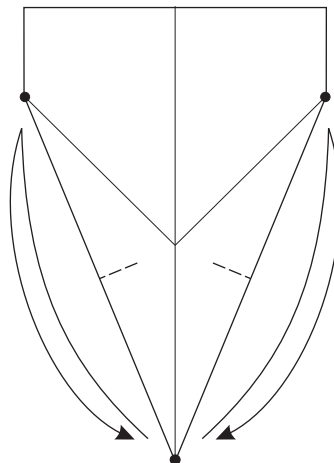
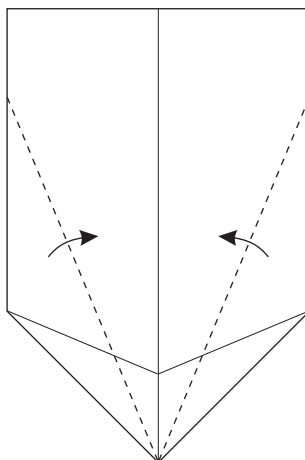
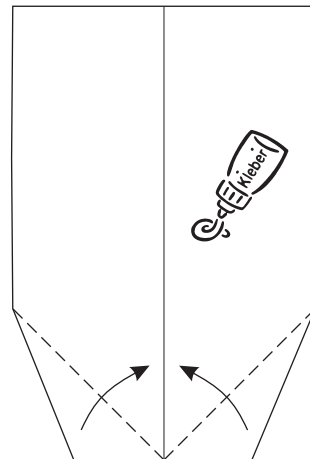
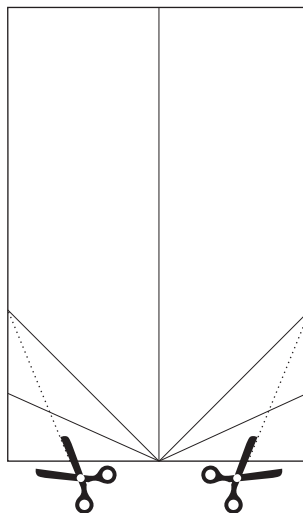
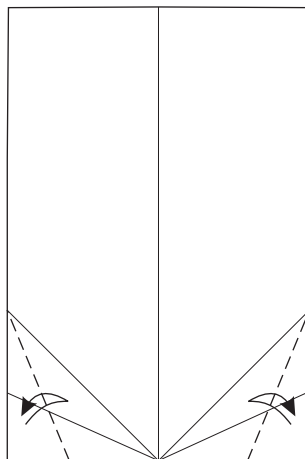
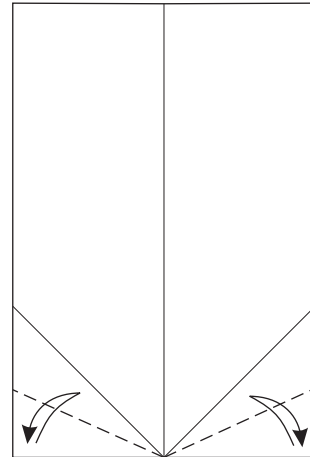
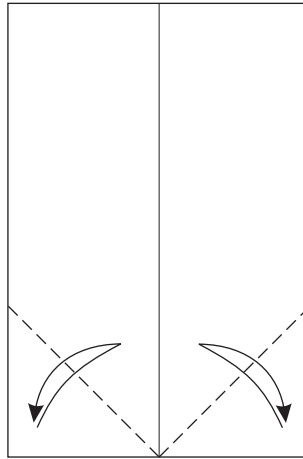
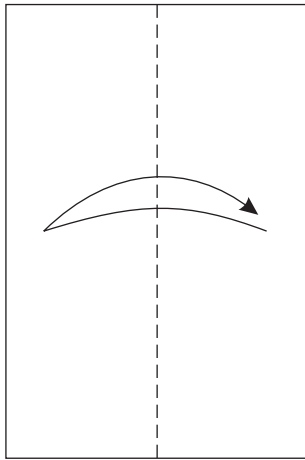

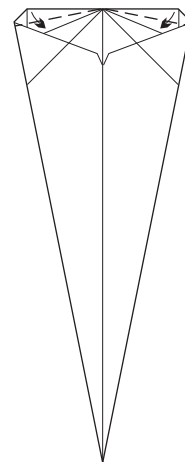
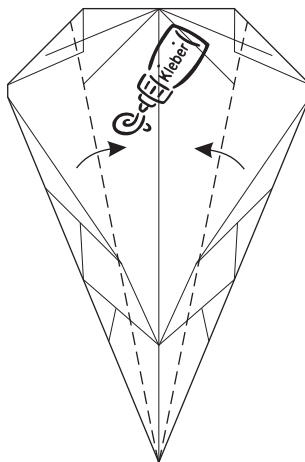
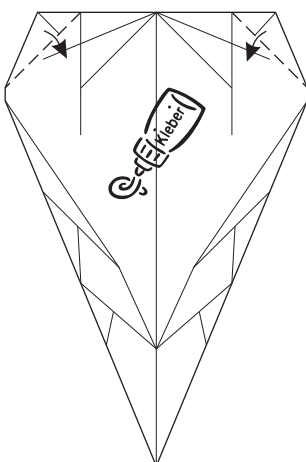
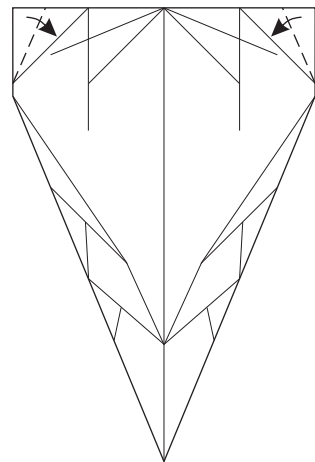
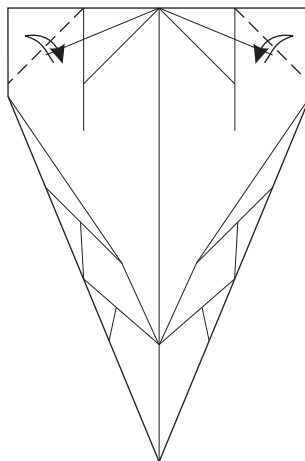
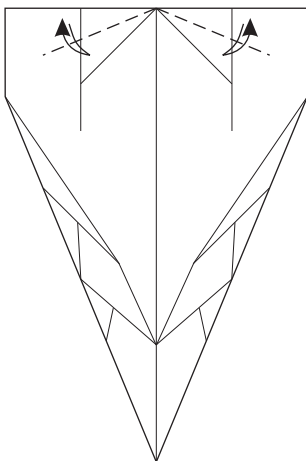
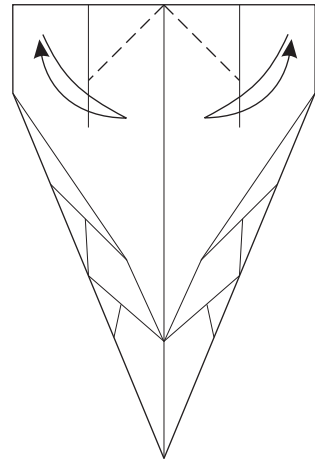
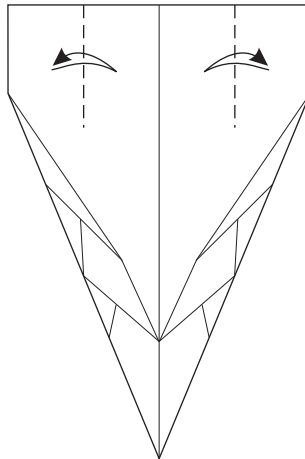
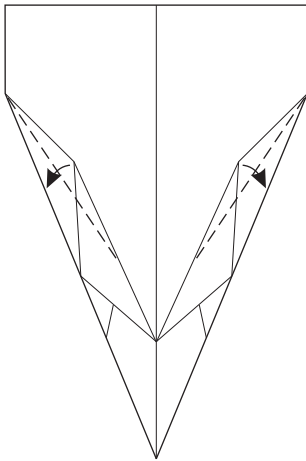

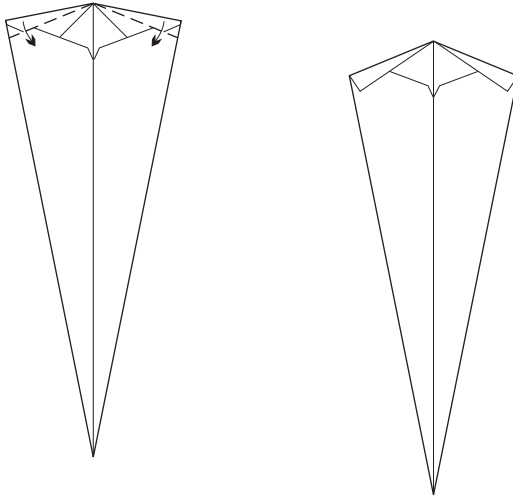

8 solcher Elemente falten und  
kreisförmig überlappend zu-  
sammenkleben.

