

Scheckkartenmäppchen

© 2006 Carlo Wingerter

Weiterentwicklung einer Idee
von Nick Robinson

Din A4 Blatt (29,7cm x 21cm)

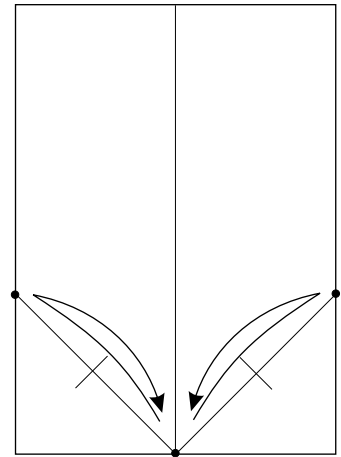
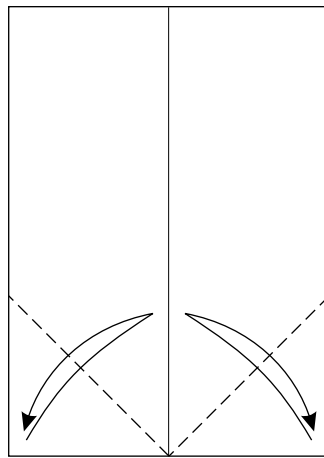
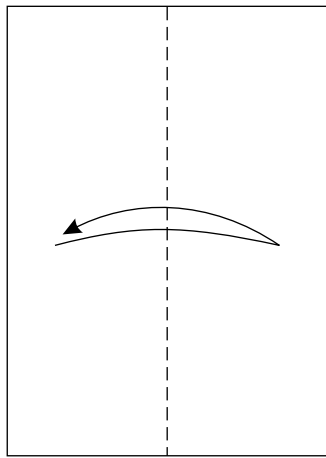

Nur die Mitte markieren.

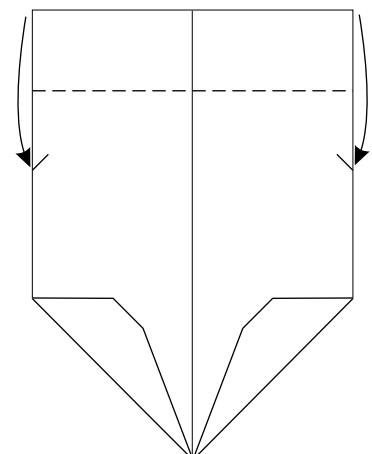
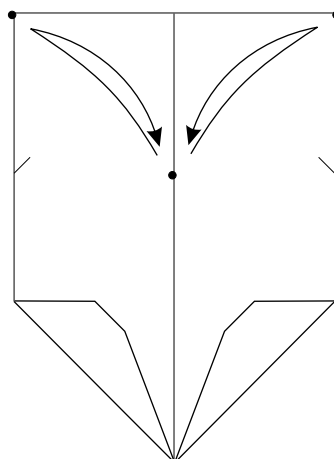
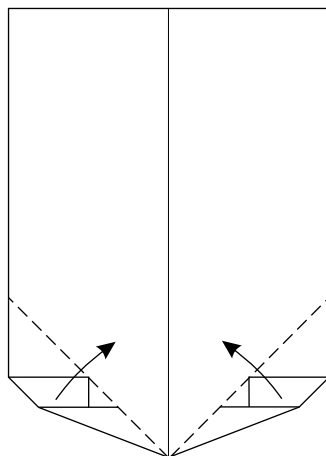
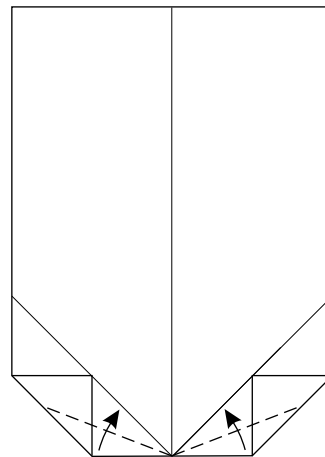
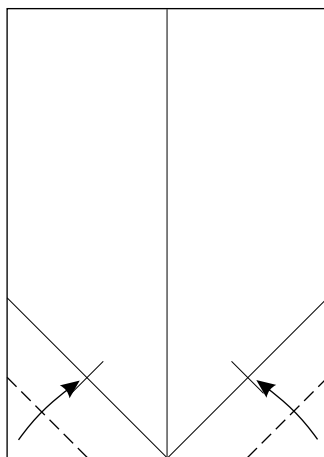

Nur Markierungsstrich knicken.

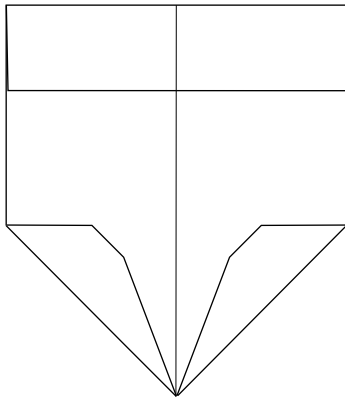

Umdrehen

etwas breiter als die Karte

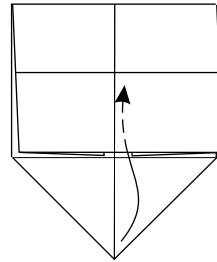
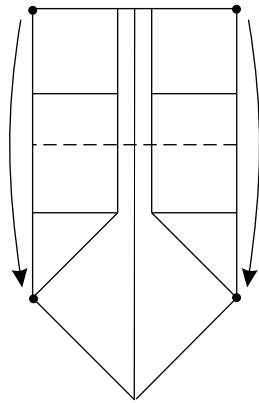
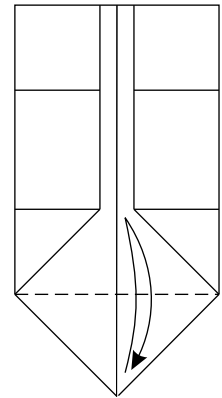
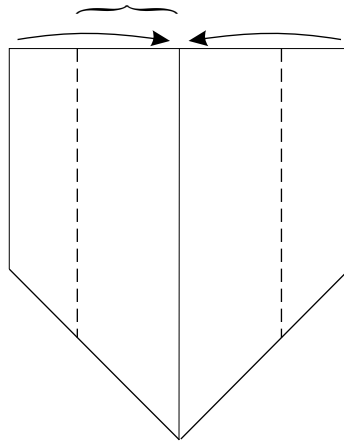

Dreieck in die Tasche stecken.



Umdrehen

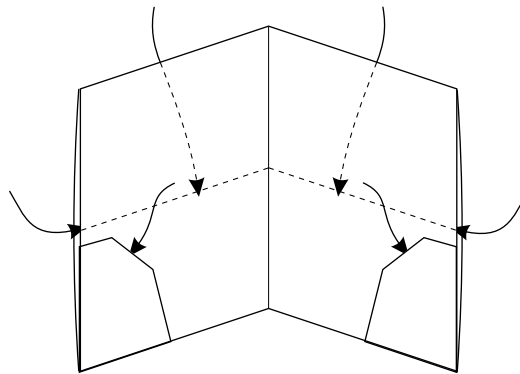

Es gibt sechs Plätze, Karten unterzubringen.